

# D3RE10

3 m<sup>3</sup>/h - 1 - 10%  
 14 GPM - 1:100 - 1:10  
 0.5 - 6 bar  
 7 - 85 psi

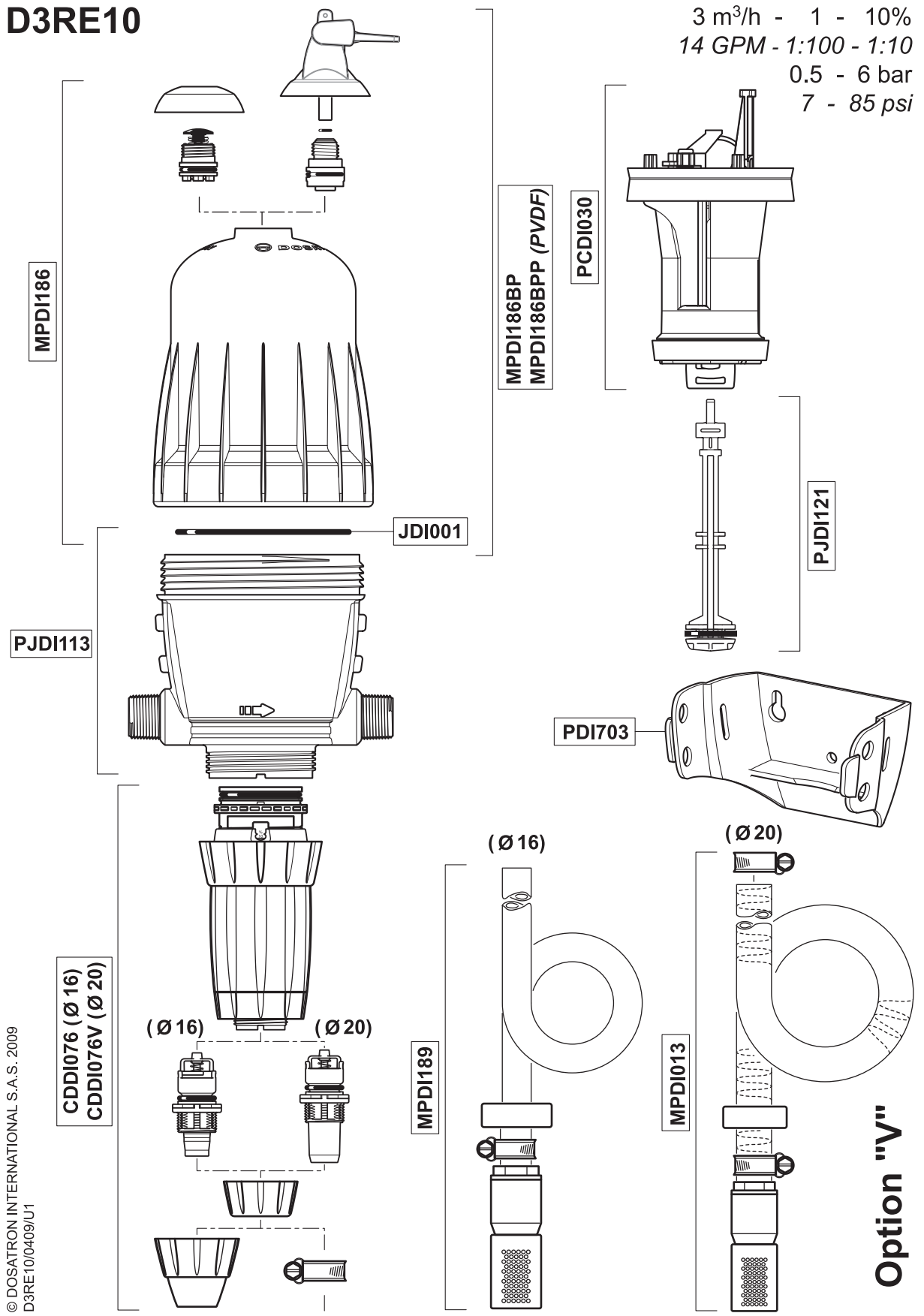

© DOSATRON INTERNATIONAL S.A.S. 2009  
 D3RE10/0409/U1

**Option "V"**

# D3RE10

3 m<sup>3</sup>/h - 1 - 10%  
 14 GPM - 1:100 - 1:10  
 0.5 - 6 bar  
 7 - 85 psi

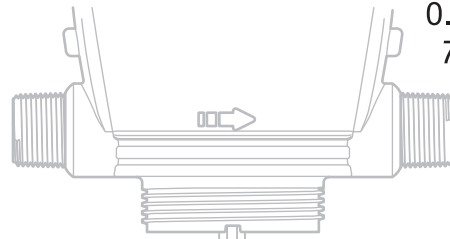
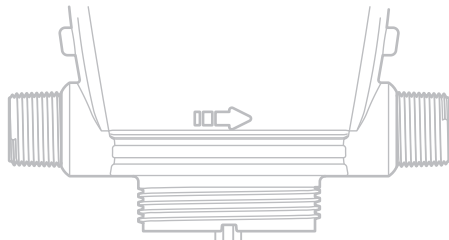

CDDI076 (Ø 16)  
 CDDI076V (Ø 20)

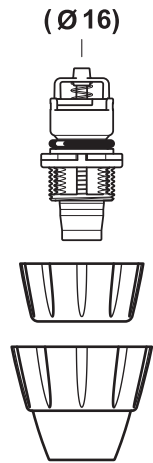
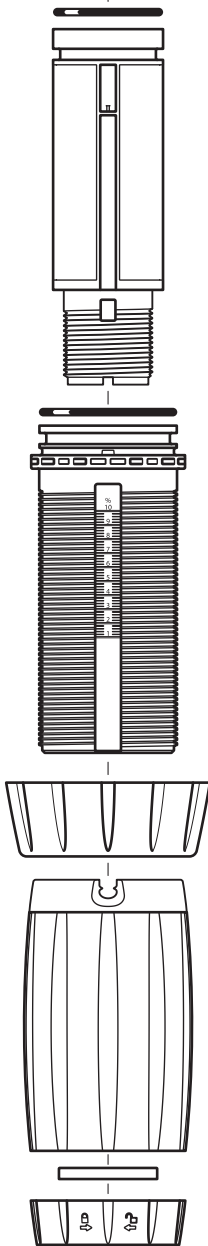

Option  
 "V"

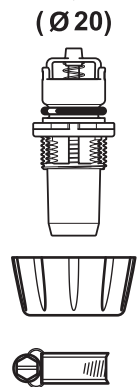

PJDI122 (Ø 16)  
 PJDI122V (Ø 20)

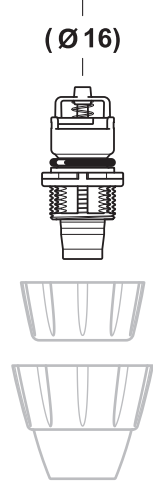
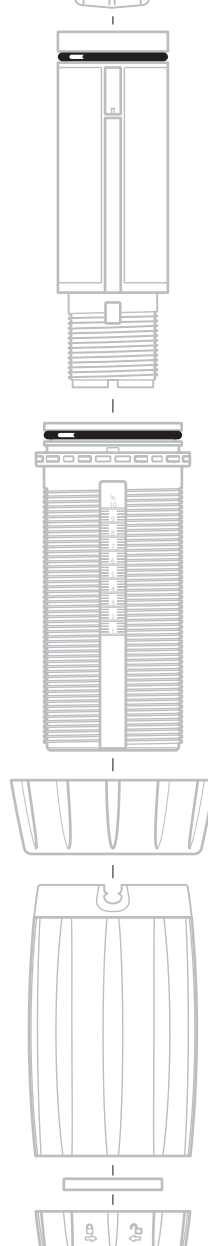

Option  
 "V"

